



**AO4800**

**Dual N-Channel Enhancement Mode Field Effect Transistor**

**General Description**

The AO4800 uses advanced trench technology to provide excellent  $R_{DS(ON)}$  and low gate charge. The two MOSFETs make a compact and efficient switch and synchronous rectifier combination for use in buck converters.

**Features**

- $V_{DS}$  (V) = 30V
- $I_D$  = 6.9A
- $R_{DS(ON)} < 27m\Omega$  ( $V_{GS} = 10V$ )
- $R_{DS(ON)} < 32m\Omega$  ( $V_{GS} = 4.5V$ )
- $R_{DS(ON)} < 50m\Omega$  ( $V_{GS} = 2.5V$ )

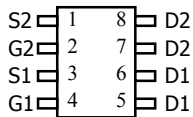

**SOIC-8**

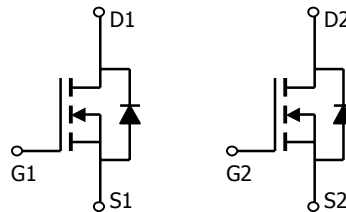

**Absolute Maximum Ratings  $T_A=25^\circ\text{C}$  unless otherwise noted**

Parameter	Symbol	Maximum	Units
Drain-Source Voltage	$V_{DS}$	30	V
Gate-Source Voltage	$V_{GS}$	$\pm 12$	V
Continuous Drain Current <sup>A</sup>	$T_A=25^\circ\text{C}$	6.9	A
	$T_A=70^\circ\text{C}$	5.8	
Pulsed Drain Current <sup>B</sup>	$I_{DM}$	40	
Power Dissipation	$T_A=25^\circ\text{C}$	2	W
	$T_A=70^\circ\text{C}$	1.44	
Junction and Storage Temperature Range	$T_J, T_{STG}$	-55 to 150	$^\circ\text{C}$

**Thermal Characteristics**

Parameter	Symbol	Typ	Max	Units
Maximum Junction-to-Ambient <sup>A</sup>	$R_{\theta JA}$	48	62.5	$^\circ\text{C/W}$
Maximum Junction-to-Ambient <sup>A</sup>		Steady-State	74	110
Maximum Junction-to-Lead <sup>C</sup>	$R_{\theta JL}$	35	40	$^\circ\text{C/W}$

Electrical Characteristics (T<sub>J</sub>=25°C unless otherwise noted)

Symbol	Parameter	Conditions	Min	Typ	Max	Units
<b>STATIC PARAMETERS</b>						
BV <sub>DSS</sub>	Drain-Source Breakdown Voltage	I <sub>D</sub> =250μA, V <sub>GS</sub> =0V	30			V
I <sub>DSS</sub>	Zero Gate Voltage Drain Current	V <sub>DS</sub> =24V, V <sub>GS</sub> =0V T <sub>J</sub> =55°C			1 5	μA
I <sub>GSS</sub>	Gate-Body leakage current	V <sub>DS</sub> =0V, V <sub>GS</sub> =±12V			100	nA
V <sub>GS(th)</sub>	Gate Threshold Voltage	V <sub>DS</sub> =V <sub>GS</sub> I <sub>D</sub> =250μA	0.7	1	1.4	V
I <sub>D(ON)</sub>	On state drain current	V <sub>GS</sub> =4.5V, V <sub>DS</sub> =5V	25			A
R <sub>DS(ON)</sub>	Static Drain-Source On-Resistance	V <sub>GS</sub> =10V, I <sub>D</sub> =6.9A T <sub>J</sub> =125°C		22.6 33	27 40	mΩ
		V <sub>GS</sub> =4.5V, I <sub>D</sub> =6.0A		27	32	
		V <sub>GS</sub> =2.5V, I <sub>D</sub> =5A		42	50	mΩ
g <sub>FS</sub>	Forward Transconductance	V <sub>DS</sub> =5V, I <sub>D</sub> =5A	12	16		S
V <sub>SD</sub>	Diode Forward Voltage	I <sub>S</sub> =1A		0.71	1	V
I <sub>S</sub>	Maximum Body-Diode Continuous Current				3	A
<b>DYNAMIC PARAMETERS</b>						
C <sub>iss</sub>	Input Capacitance	V <sub>GS</sub> =0V, V <sub>DS</sub> =15V, f=1MHz		858		pF
C <sub>oss</sub>	Output Capacitance			110		pF
C <sub>riss</sub>	Reverse Transfer Capacitance			80		pF
R <sub>g</sub>	Gate resistance	V <sub>GS</sub> =0V, V <sub>DS</sub> =0V, f=1MHz		1.24		Ω
<b>SWITCHING PARAMETERS</b>						
Q <sub>g</sub>	Total Gate Charge	V <sub>GS</sub> =4.5V, V <sub>DS</sub> =15V, I <sub>D</sub> =6.9A		9.6		nC
Q <sub>gs</sub>	Gate Source Charge			1.65		nC
Q <sub>gd</sub>	Gate Drain Charge			3		nC
t <sub>D(on)</sub>	Turn-On DelayTime	V <sub>GS</sub> =10V, V <sub>DS</sub> =15V, R <sub>L</sub> =2.2Ω, R <sub>GEN</sub> =6Ω		5.7		ns
t <sub>r</sub>	Turn-On Rise Time			13		ns
t <sub>D(off)</sub>	Turn-Off DelayTime			37		ns
t <sub>f</sub>	Turn-Off Fall Time			4.2		ns
t <sub>rr</sub>	Body Diode Reverse Recovery time	I <sub>F</sub> =5A, dI/dt=100A/μs		15.5		ns
Q <sub>rr</sub>	Body Diode Reverse Recovery charge	I <sub>F</sub> =5A, dI/dt=100A/μs		7.9		nC

A: The value of R<sub>θJA</sub> is measured with the device mounted on 1in<sup>2</sup> FR-4 board with 2oz. Copper, in a still air environment with T<sub>A</sub>=25°C. The value in any a given application depends on the user's specific board design. The current rating is based on the t<sub>s</sub> ≤ 10s thermal resistance rating.

B: Repetitive rating, pulse width limited by junction temperature.

C: The R<sub>θJA</sub> is the sum of the thermal impedance from junction to lead R<sub>θJL</sub> and lead to ambient.

D: The static characteristics in Figures 1 to 6 are obtained using 80μs pulses, duty cycle 0.5% max.

E: These tests are performed with the device mounted on 1 in<sup>2</sup> FR-4 board with 2oz. Copper, in a still air environment with T<sub>A</sub>=25°C. The SOA curve provides a single pulse rating.

TYPICAL ELECTRICAL AND THERMAL CHARACTERISTICS

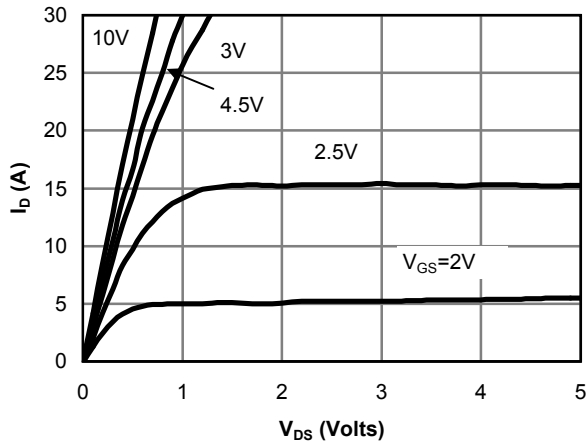

Fig 1: On-Region Characteristics

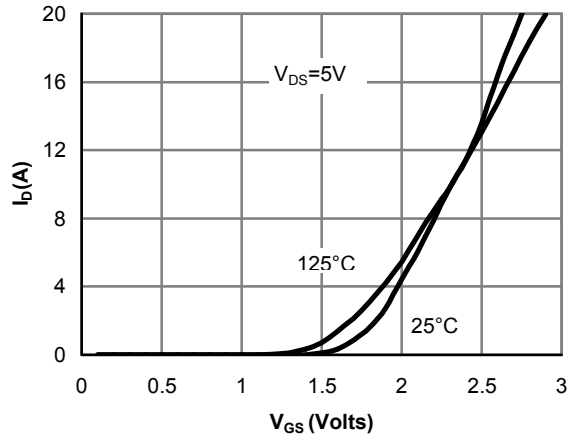

Figure 2: Transfer Characteristics

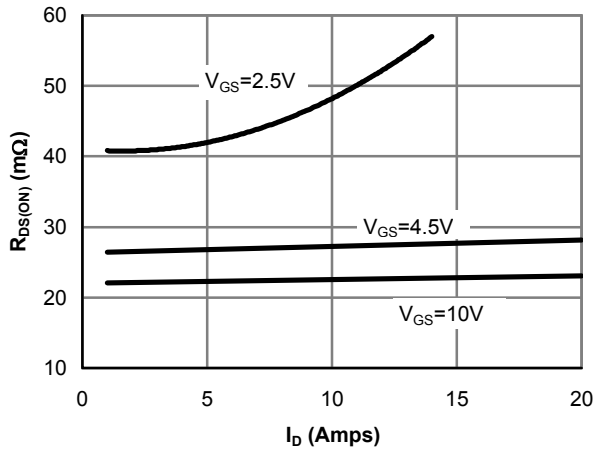

Figure 3: On-Resistance vs. Drain Current and Gate Voltage

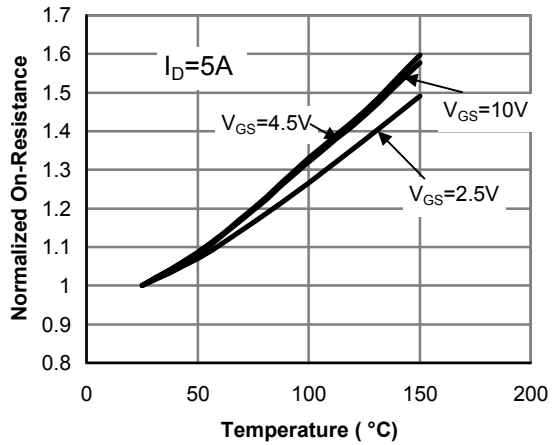

Figure 4: On-Resistance vs. Junction Temperature

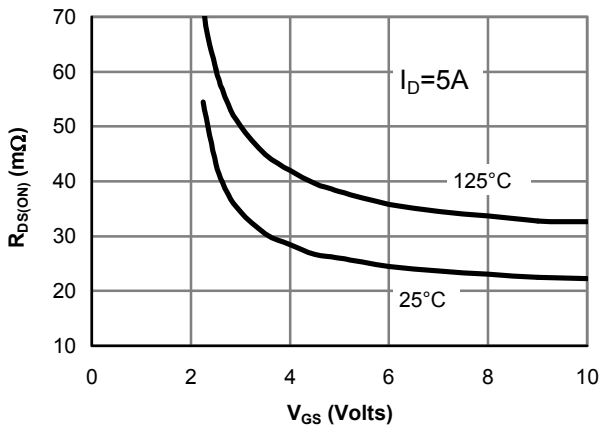

Figure 5: On-Resistance vs. Gate-Source Voltage

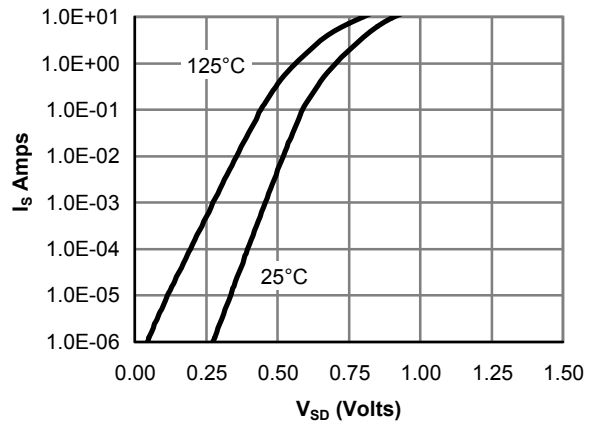

Figure 6: Body diode characteristics

TYPICAL ELECTRICAL AND THERMAL CHARACTERISTICS

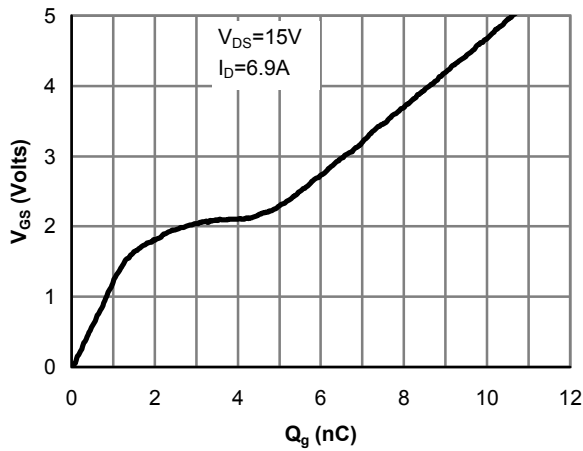

Figure 7: Gate-Charge characteristics

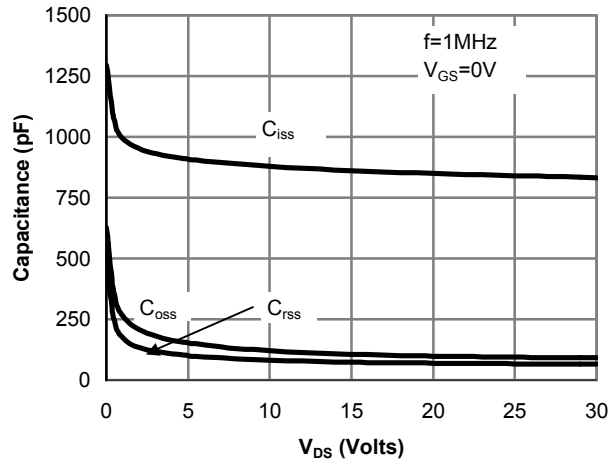

Figure 8: Capacitance Characteristics

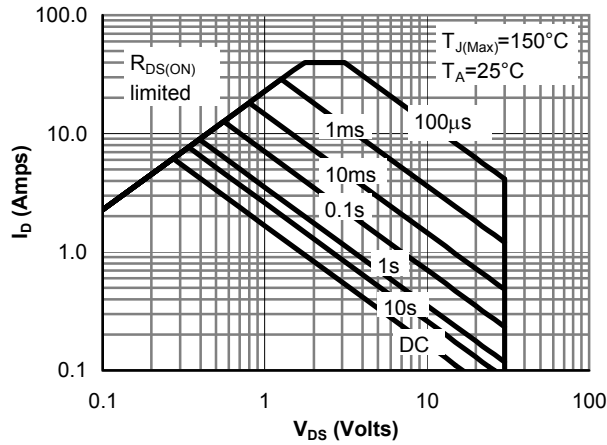

Figure 9: Maximum Forward Biased Safe Operating Area (Note E)

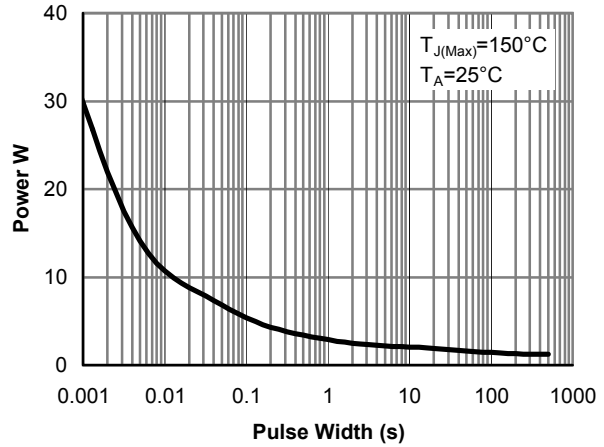

Figure 10: Single Pulse Power Rating Junction-to-Ambient (Note E)

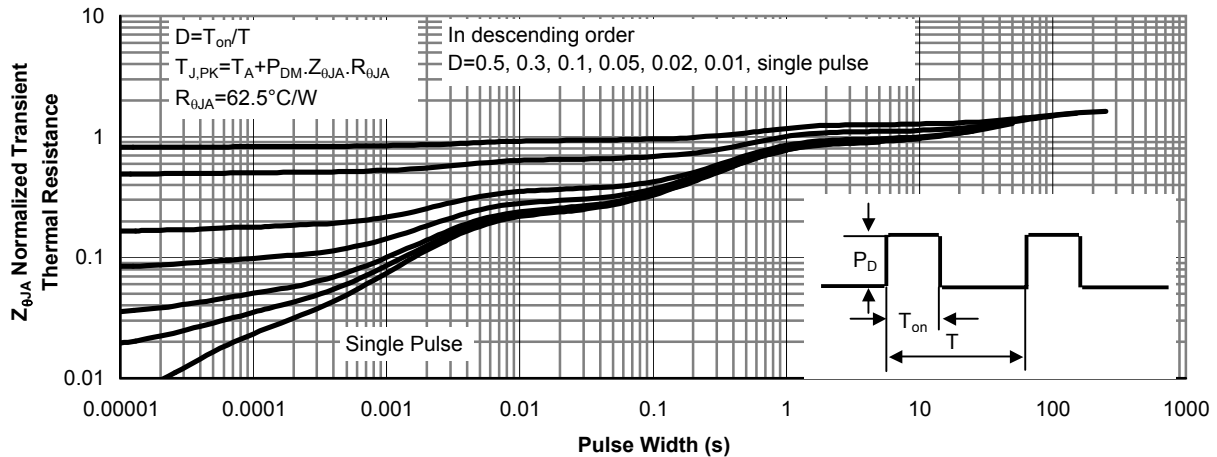
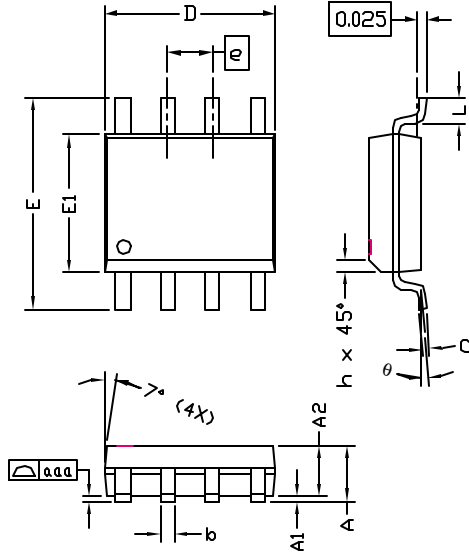

Figure 11: Normalized Maximum Transient Thermal Impedance



**ALPHA & OMEGA**  
SEMICONDUCTOR, INC.

## SO-8 Package Data



SYMBOLS	DIMENSIONS IN MILLIMETERS			DIMENSIONS IN INCHES		
	MIN	NOM	MAX	MIN	NOM	MAX
A	1.45	1.50	1.55	0.057	0.059	0.061
A1	0.00	—	0.10	0.000	—	0.004
A2	—	1.45	—	—	0.057	—
b	0.33	—	0.51	0.013	—	0.020
c	0.19	—	0.25	0.007	—	0.010
D	4.80	—	5.00	0.189	—	0.197
E1	3.80	—	4.00	0.150	—	0.157
e	1.27 BSC			0.050 BSC		
E	5.80	—	6.20	0.228	—	0.244
h	0.25	—	0.50	0.010	—	0.020
L	0.40	—	1.27	0.016	—	0.050
aaa	—	—	0.10	—	—	0.004
θ	0°	—	8°	0°	—	8°

- NOTE:  
 1. LEAD FINISH: 150 MICRONS ( 3.8 um) MIN.  
 THICKNESS OF Tin/Lead (SOLDER) PLATED ON LEAD  
 2. TOLERANCE ±0.100 mm (4 mil) UNLESS OTHERWISE SPECIFIED  
 3. COPLANARITY : 0.1000 mm  
 4. DIMENSION L IS MEASURED IN GAGE PLANE

### PACKAGE MARKING DESCRIPTION

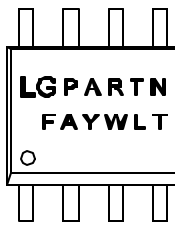

- NOTE:  
 LG - AOS LOGO  
 PARTN - PART NUMBER CODE.  
 F - FAB LOCATION  
 A - ASSEMBLY LOCATION  
 Y - YEAR CODE  
 W - WEEK CODE.  
 L N - ASSEMBLY LOT CODE

### SO-8 PART NO. CODE

PART NO.	CODE	PART NO.	CODE	PART NO.	CODE
AO4400	4400	AO4800	4800	AO4700	4700
AO4401	4401	AO4801	4801	AO4701	4701

### RECOMMENDED LAND PATTERN

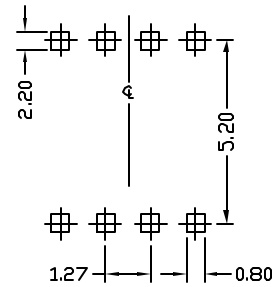

UNIT: mm



SO-8 Carrier Tape

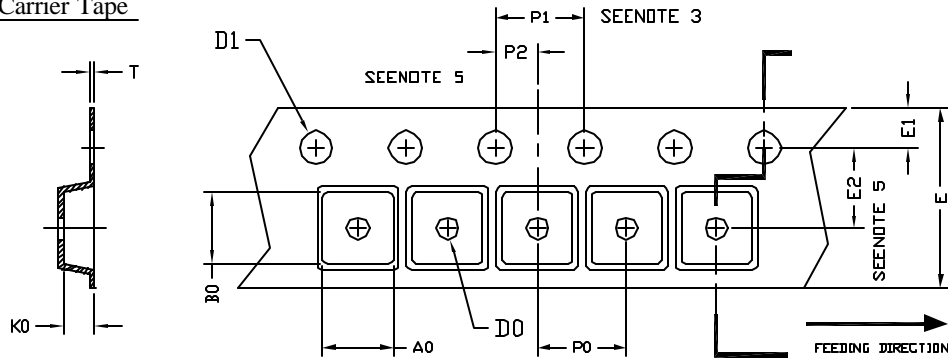

UNIT: MM

PACKAGE	A0	B0	K0	D0	D1	E	E1	E2	P0	P1	P2	T
SO-8 (12 mm)	6.40 ±0.10	5.20 ±0.10	2.10 ±0.10	1.60 ±0.10	1.30 +0.10	12.00 ±0.30	1.75 ±0.10	5.50 ±0.05	8.00 ±0.10	4.00 ±0.10	2.00 ±0.05	0.25 ±0.05

SO-8 Reel

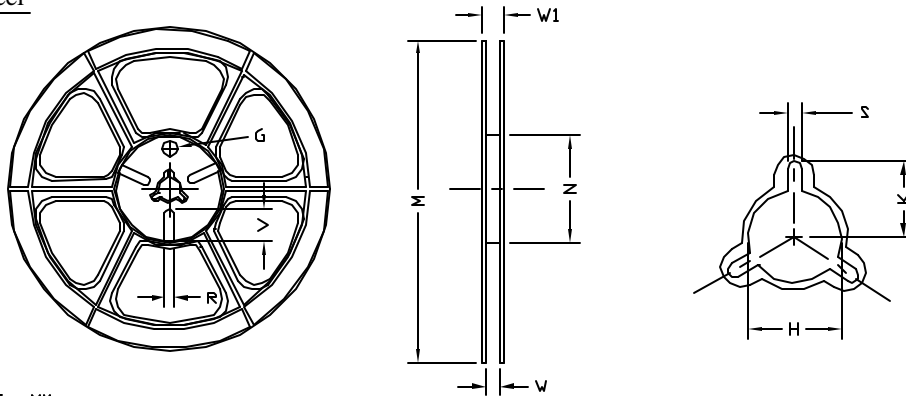

UNIT: MM

TAPE SIZE	REEL SIZE	M	N	W	W1	H	K	S	G	R	V
12 mm	φ330	φ330.00 ±0.50	φ97.00 ±0.10	13.00 ±0.30	17.40 ±1.00	φ13.00 +0.50 -0.20	10.60	2.00 ±0.50	---	---	---

SO-8 Tape

Leader / Trailer  
& Orientation

